

Data Sheet

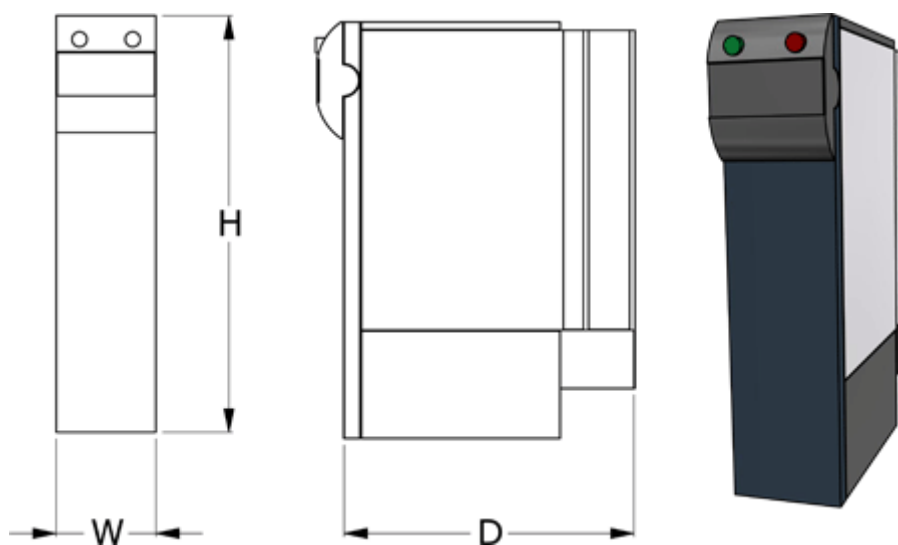

Article number: 1080401151000
Description: Servocontroller ACU401-15-FA
3 kW 6,8A 3x400V IP20

Measures



D = 175
H = 250
W = 60
Weight = 1.6